

E0L800-80058

说明书技术要求

技术要求

1. 纸张边角应裁剪整齐；印刷字迹清晰整洁、内容正确，没有明显的拖墨和重影等缺陷；
2. 纸质为 $80\text{g}/\text{m}^2$ ；
3. 未注公差按GB/T1804-c级；
4. 版面为A5；
5. 颜色要求:黑色K100；

				TCC-24D2HWH/DVI(02)	85008-008703		
C	GG.2308-0454	郑圣鹏	230811	变频D2风管机说明书	阶段标记	质量	比例
B	GG.2307-0864	郑圣鹏	230718				
版次	更改文件号		签字	日期			
设计	陈晓滨	2023-6-27	工艺	崔中良	广东TCL智能暖通设备有限公司		
校对	陈建铭		标准化	林东运			
审核	杨瑞		批准	刘健			
				共 1 张	第 1 张		



INSTALLATION & OPERATION MANUAL

INVERTER DUCT TYPE

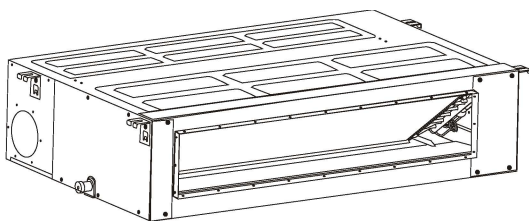





YD18T1/I, YD18T1/O
YD24T1/I, YD24T1/O
YD42T1/I, YD42T1/O
YD48T1T/I, YD48T1T/O
YD55T1T/I, YD55T1T/O

This instruction manual contains important information and recommendations that we would ask you to comply with to obtain best results from air conditioner.

Thank you once again.

Safety Notice

	The air conditioner is charged with inflammable refrigerant R32.
	Before using the air conditioner, please first read the instruction manual.
	Before installing the air conditioner, please first read the instruction manual.
	Before repairing the air conditioner, please first read the technical service manual.



Compared with common refrigerant, R32 is an environmental-friendly refrigerant that has no harm to the ozone layer and weak greenhouse effect. Its GWP is 675. Because of its thermodynamic characteristics, R32 requires a smaller charging quantity to reach high energy efficiency. It is inflammable and odourless, but may cause explosion under certain circumstances.

CONTENTS

PRECAUTION	1
PARTS AND FUNCTIONS	3
TROUBLES AND CAUSES	6
IMPORTANT SAFETY INFORMATION	7
INDOOR UNIT INSTALLATION	8
DRAINAGE PIPE INSTALLATION	11
FIGURE OF BODY SIZE	13
OUTDOOR UNIT INSTALLATION	17
REFRIGERANT PIPE INSTALLATION	19
ELECTRIC WIRING	21
TRY TEST	24
DISPLAY PANEL	25
TROUBLESHOOTING	26
REFRIGERANT NOTICE/CONCENTRATION	28

PRECAUTION

- Read the following " PRECAUTIONS" carefully before installation.
- The caution items stated here must be followed because these important contents are related to safety. The meaning of each indication used is as below.
Incorrect installation due to ignoring of the instruction will cause harm or damage, and the seriousness is classified by the following indications.

 WARNING	This indication shows the possibility of causing death or serious injury.
 CAUTION	This indication shows the possibility of causing injury or damage to properties only.

NOTE :

1. Injury means causing harmed, burned, electrical shocked, but not serious for hospitalization.
 2. Damage of property means disrepair of property, material.
- Carry out test running to confirm that no abnormality occurs after the installation. Then, explain to user the operation, care and maintenance as stated in instructions. Please remind the customer to keep the operating instructions for future reference.

 WARNING
● Engage dealer or specialist for installation. If installation done by user is defective, it will cause water leakage, electrical shock or fire.
● Install according to this installation instructions strictly. If installation is defective, it will cause water leakage, electrical shock or fire.
● Use the attached accessories parts and specified parts for installation. Otherwise, it will cause the set to fall, water leakage, fire or electrical shock.
● Install at a strong and firm location which is able to withstand the set's weight. If the strength is not enough or installation is not properly done, the set will drop and cause injury.
● For electrical work, follow the local national wiring standard, regulation and this installation instructions. An independent circuit and single outlet must be used. If electrical circuit capacity is not enough or defect found in electrical work, it will cause electrical shock or fire.
● When carrying out piping connection, take care not to let air or other substances other than the specified refrigerant go into refrigeration cycle. Otherwise, it will cause lower capacity, abnormal high pressure in the refrigeration cycle, explosion and injury.
● Grounding is necessary. It may cause electrical shock if grounding is not perfect.
● Do not install the unit at place where leakage of flammable gas may occur. In case gas leaks and accumulates at surrounding of the unit, it may cause fire.

Operating condition

The protective device maybe trip and stop the unit within temp range listed below:

HEATING	Outdoor air temperature is over 24°C
	Outdoor air temperature is below -15°C Room temperature is over 27°C
COOLING	Outdoor air temperature is over 50°C Outdoor air temperature is below -15°C Room temperature is below 17°C
	Room temperature is below 17°C
DRY	Room temperature is below 17°C

If the air conditioner runs for a long time in "COOLING" or "DRY" mode at air relative humidity higher than 80% (doors or windows opened), dew may generate and drip near air outlet.

Noise pollution

- Install the air conditioner in a place that can bear its weight in order to operate more quietly.
- Install the outdoor unit in a place where the air discharged and the operation noise do not annoy your neighbors.
- Do not place any obstacles in front of the outlet of the outdoor unit for fear it affects operation and increases the noise level.

Features of Protector

- ① The protective device will trip at following cases.
 - Stop the appliance and restart it at once or change other modes during operation, you have to wait 3 minutes before restarting.
 - After switching on the power circuit breaker and then turn on the air conditioner at once, you have to wait about 20 seconds.
- ② In case all operations have stopped, you need
 - Press "ON/OFF" button again to restart it.
 - Set TIMER once again if it has been canceled.

Inspection

After a long time of operation, the air conditioner should be inspected for the following items.

- Abnormal heating of the power supply cord and plug or even a burnt smell.
- Abnormal operating noise or vibration.
- Water leakage from indoor unit.
- Metal cabinet electrified .
- ✎ Stop using the air conditioner if above problem happened.
It is advisable that the air conditioner should be given a detail check-up after using for five years even if none of the above happen.

Feature of HEATING mode

Preheat

2-5 minutes are necessary to preheat the indoor heat exchanger at the beginning of "HEATING" operation, lest cold air be discharged.

Defrost

In "HEATING" operation the appliance will defrost automatically. This procedure lasts 2~10 minutes, then returns to "HEATING" mode automatically. During defrosting, indoor fan stop running and return to heating mode operation automatically when defrosting has finished.

PARTS AND FUNCTIONS

Indoor Unit

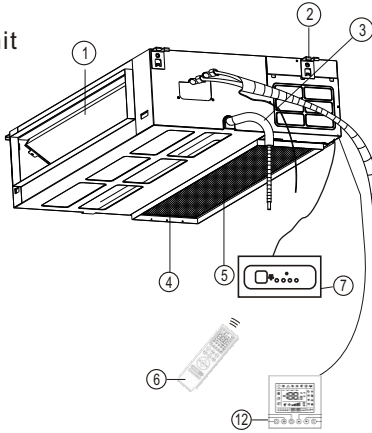

Outdoor Unit

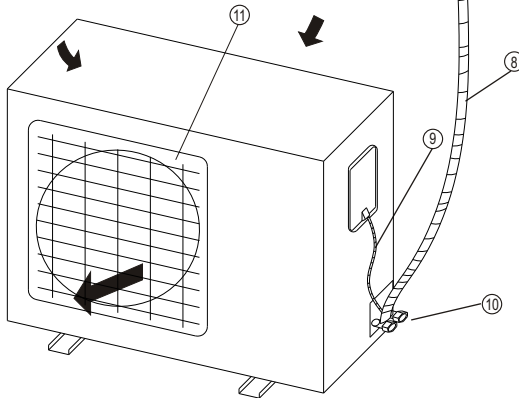

- ① Air Outlet
- ② Hook
- ③ Drainage Pipe
- ④ Air Return
- ⑤ Filter
- ⑥ Remote controller
- ⑦ Remote controller receiver
- ⑧ Refrigerant connection pipe
- ⑨ Connecting cord
- ⑩ Stop valve
- ⑪ Air Outlet grille
- ⑫ Wire controller

Requirements

- The air conditioner cannot be started up until it is powered on for 2 hours. Furthermore, in case of a shutdown lasting for about one diel only, please do not cut off the electricity supply. (it is necessary to heat the crankcase heater so as to avoid force start of compressor.)
-

Notice that the air inlet/outlet must not be choked up. If chokeup takes place, the air conditioner behavior may be affected, or air conditioner cannot run because of

REMOTE CONTROLLER

KW86J1 Wire Controller

Please see the detailed instructions for the KW-86J1 wire controller

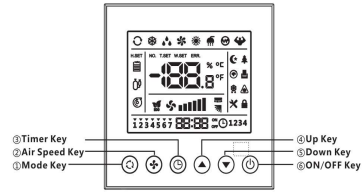

No.	Symbols	Meaning
1		Battery indicator
2		Auto Mode
3		Cooling Mode
4		Dry Mode
5		Fan only Mode
6		Heating Mode
7		ECO Mode
8		Timer
9	88.8 ^{°C}	Temperature indicator
10		Fan Speed: Auto/low/low-mid/mid/mid-high/high
11		Mute function
12		TURBO function
13		Up-down auto swing
14		Left-right auto swing
15		SLEEP function
16		Health function
17		I FEEL function
18	8H	8°C heating function
19		Signal indicator
20		Gentle wind
21		Child-Lock
22		Display ON/OFF
23		GEN function
24		Self-Clean function
25		Anti-Mildew



The display and some functions of the remote control may vary according to the model.

■ Air flow direction adjustment procedure

Adjusting air flow direction

- Up/down direction can be adjusted by using the AIRFLOW button on the remote controller. This button, each time pressed, changes the mode in the following sequence:

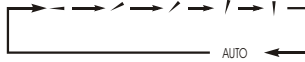

- push the LOUVER button, changes the mode to swing louver. Push the button, to stop swing.

NOTE

- When the room temperature controller (thermostat) trips in the heating mode or when the defrosting operation is conducted, the blow flap changes automatically to the horizontal position.
- When the heating operation has just started and the room temperature is still low, it may take a little time before the flap moves to the above sway operation angle.
- The flap may stop at the tilted down-blow position during the "Sway operation" in the heating mode.

■ About TIMER operation

About Amenity reservation

Amenity reservation function is provided to start the operation a little earlier so that the room temperature is near the optimum temperature at the timer ON time in case of starting the operation by TIMER ON/OFF.

- Mechanism
Checking of the room temperature starts 60 minutes ahead of the timer ON time. Depending on the temperature at that time, operation starts 5 to 60 minutes ahead of the timer ON time.
- Amenity reservation is the function only for COOL and HEAT operation mode (including AUTO). It does not actuate in DRY mode.

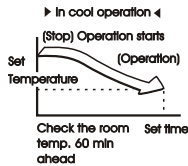

About SLEEP Operation

When the SLEEP operation is selected, the room temperature is automatically controlled with elapsed time so that the room isn't too cool during cooling or too warm during heating.

■ About power-off memory function

- When the air conditioner disconnects the power suddenly, restart it, the air conditioner operates at the mode it did before power suddenly failed.

These are not failures

Room air is smelly.

A bad odor comes from the air conditioner.

- Smells impregnated in the wall, carpet, furniture, clothing, or furs, are coming out. A white mist of chilled air or water is generated from the outdoor unit.

CAUTION

If any of the following conditions occur, stop the air conditioner immediately, set off the power switch, and contact the dealer.

- The indicator lamps flash rapidly (five times per second), you disconnect the unit with the power and then connect the unit with the power again after two or three minutes but the lamps still flash.
- Switch operations are erratic.
- The fuse is blown frequently or the circuit breaker is tripped frequently.
- Foreign matter or water has fallen inside the air conditioner.
- Any other unusual condition is observed.

TROUBLES AND CAUSES

(ABOUT REMOTE CONTROLLER)

Before you ask for service or repairs, check the following points.

Setting change is impossible.		
Symptoms	Causes	Reason and Disposal
The fan speed can not be changed.	● Check whether the MODE indicated on the display is "AUTO".	When the automatic mode is selected, the air conditioner automatically selects the fan speed.
	● Check whether the MODE indicated on the display is "DRY".	When dry operation is selected, the air conditioner automatically select the fan speed. The fan speed can be selected during "COOL" and "FAN ONLY," and "HEAT."
The Transmission Indicator ▲ never comes on		
Symptoms	Causes	Reason and Disposal
The remote control signal is not transmitted even when the ON/FF button is pushed.	● Check whether the batteries in the remote controller are exhausted.	The remote control signal is not transmitted, because the power supply is off.
The Display never comes On		
Symptoms	Causes	Reason
The TEMP. indicator does not come on.	● Check whether the MODE indicated on the display is "FAN ONLY".	The temperature cannot be set during fan only operation.

HAND OVER TO CUSTOMERS

INSTALLATION MANUAL of indoor and outdoor unit must be handed over to the customers.

Please narrate the manual to the customers in details.

IMPORTANT SAFETY INFORMATION

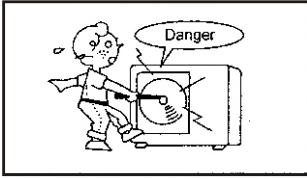

▲CAUTION

Do not attempt to install this unit by yourself. This unit requires installation by qualified persons.

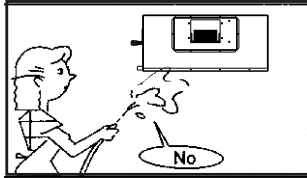

▲DANGER

Do not attempt to service the unit yourself. This unit has no user serviceable components. Opening or removing the cover will expose you to dangerous voltage. Turning off the power supply will not prevent potential electric shock.

▲DANGER

Never put hands or objects into the air outlet of indoor or outdoor units. These units are installed with a fan running at high speed. To touch the moving fan will cause serious injury.

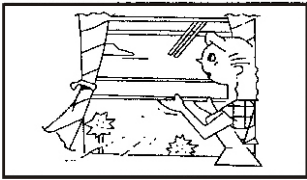

▲DANGER

To avoid the risk of serious electrical shock. Never sprinkle or spill water or liquids on unit.

▲WARNING

Ventilate the room regularly while the air conditioner is in use, especially if there is also a gas appliance in use in this room. Failure to follow these directions may result in a loss of oxygen in the room.

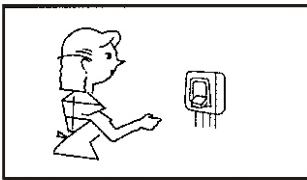

▲WARNING

To prevent electric shock, turn off the power or disconnect the power supply plug before beginning any cleaning or other routine maintenance.

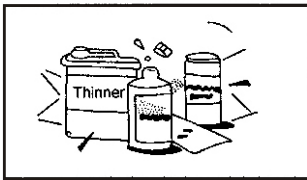

▲WARNING

Do not use liquid cleaners or aerosol cleaners, use a soft and dry cloth for cleaning the unit. To avoid electric shock, never attempt to clean the units by sprinkling water.

▲CAUTION

Do not use caustic household drain cleaners in the unit. Drain cleaners can quickly destroy the unit components (drain pan and heat exchanger coil etc).

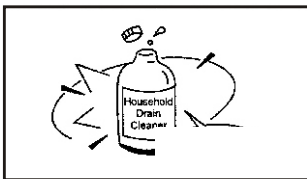

▲NOTE

For proper performance, operate the unit in temperature and humidity ranges indicated in this owner's manual. If the unit is operated beyond these conditions, it may cause malfunctions of the unit or dew dripping from the unit.

INDOOR UNIT INSTALLATION

Pre-installation precautions

● Please confirm that the installation personnel are qualified in relevant installation service. If the air conditioner was installed by persons without special skills, normal operations would not be ensured, even the personal and estate safety would be affected

The air conditioner must be correctly installed by installation technicians according to the attached 《Installation Manual》, and the user himself should not install it.

User guideline

- The user's installation site should be provided with regular power supply in conformity with that indicated in nameplate of the air conditioner, and its voltage should be within a range 90 %~ 110 % of the rated voltage value.
- Power circuit should be equipped with protector, such as electricity leakage protector or air switch, which should possess a capacity greater than 1.5 times the maximum current value of the air conditioner.
- Never fail to adopt personal circuit and effectively-grounded socket compatible with the attached plug of the air conditioner. The attached plug is equipped with grounding pin, and it must not be modified as desired.
- Please adopt the fuse or circuit breaker prescribed in Installation Instructions.
- Only qualified electrician is allowed to carry out wiring tasks strictly according to electric safety requirements.
- Do ensure good earth of air conditioner, in other words, the main power switch of air conditioner must be connected to reliable ground wire

Precautions

- The air conditioner should be installed securely; otherwise poor installation may lead to abnormal noises and vibration.
- Outdoor unit should be installed at a spot ensuring that its air outlet noises and hot exhaust will not violate your neighbors.

Choice of air return ways

This indoor unit is fitted with downward air return, which can be change to its backward counterpart if necessary. Please follow the steps below(2-5) to change it into the mode of air return backward(6).

1. Air return downward

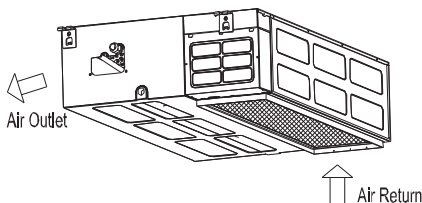

2. Loose the nut and dismantle flannel plate and filter; Loose the nut dismantel the back over.

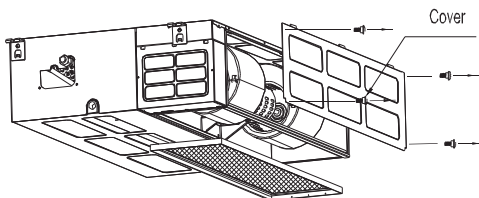

3. Install the flannel plate and filter at the backside; Install the cover to the downside.

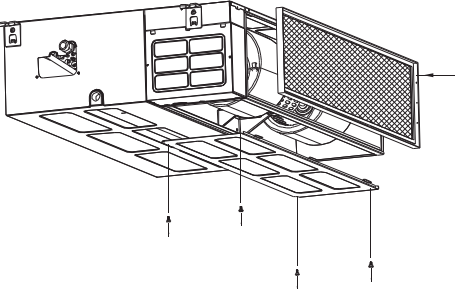

4. Airreturn backward.

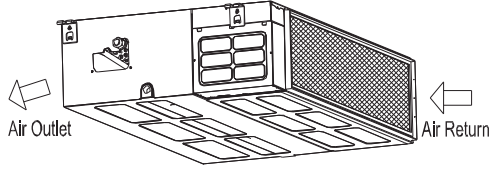

Installation Space

Ensure sufficient space for installation and repair.

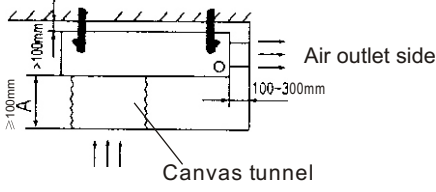

Wooden construction

Put the square timber over the roof beam, then install the hanging screw bolt.

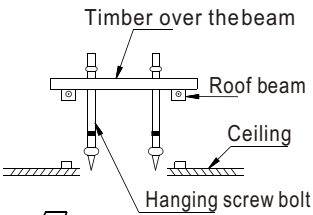

New concrete bricks

Inlaying or embedding the screw bolts

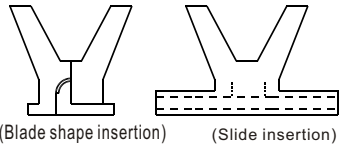

Finished concrete bricks

Install the hanging hook with expansible bolt into the concrete deep to 45-50mm to prevent loose.

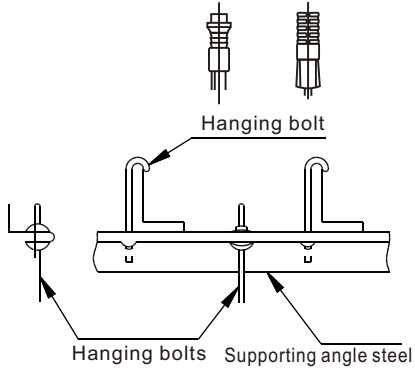

Steel roof beam structure

Make use of steel in the ceiling or supporting angle steel..

Hanging & Installation of Indoor Unit

Adjust the nut position while the gap between gasket(downside) and ceiling should be confirmed according to actual situations.

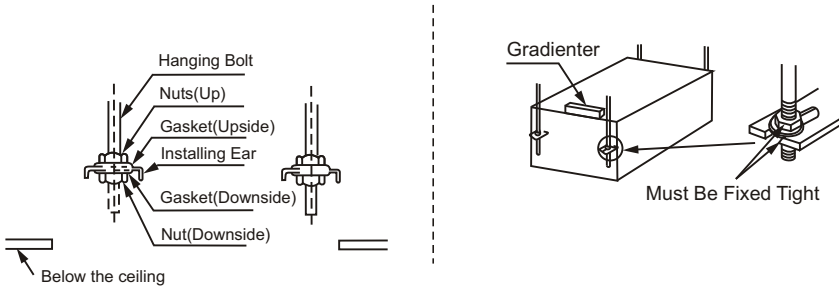

Hang the nut inside the U slot of the installation panel. To confirm level degree with gradienter .
 (Leaning downside toward non-draining side is prohibited)

2. How to mount outlet pipe

- Generally, we have two types of outlet pipe available, i.e. rectangular or round ones.
- Rectangular air conduit can be directly connected to air outlet of indoor unit by rivets. For outlet dimensions, see outline drawing of the unit.
- Round air conduit should be connected to a piece of transitional air conduit before it is connected to air outlet of indoor unit, the other end of it can be separately connected to air conduit window or connected to air conduit window after air flow diversion, and the total length should not be over 6m. As shown in figure below, air speeds at all air outlets should be set to basically consistent so as to meet the room air-conditioning requirements.

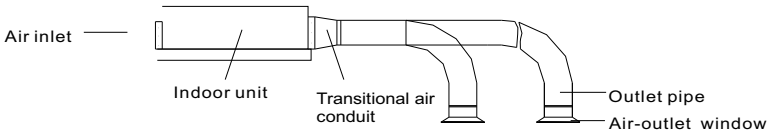

3. Installation method for return air pipe

- In case sidewise air intake is adopted, return air pipe should be fabricated and rivet-connected to return air orifice, and the other end of it should be connected to return air window.
- In case of underside air intake, purchase or fabricate a section of pleated canvas air conduit serving as transition joint for return air orifice and return air window. In this way, it can be freely adjusted according to height of indoor ceiling board; in addition, during operation of the unit, canvas air conduit may avoid vibration of ceiling board, as shown in figure below.

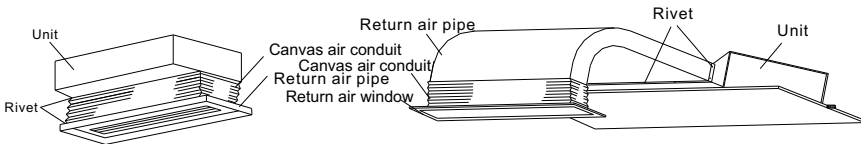

Installation mode for underside air intake

Installation mode for sidewise air intake

4. Tips for installation of return air pipe and outlet pipe

● To minimize energy loss occurring in transmission process and condensed water during heating operation, return air pipe and outlet pipe should be equipped with heat-insulating layer as shown in the figure.

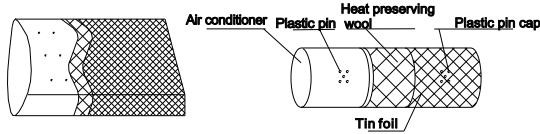

● Return air pipe and outlet pipe should be fixed to floor precast slabs by iron stand; in addition, all ports of the air conduit should be tightly sealed by gasket cement, and it is advisable that the edge clearance of return air pipe should be 150mm at least.

● Drain pipe for condensed water should be installed with minimum gradient of 1 %, and the drain pipe should be insulated with heat-preserving pipe casing as well.

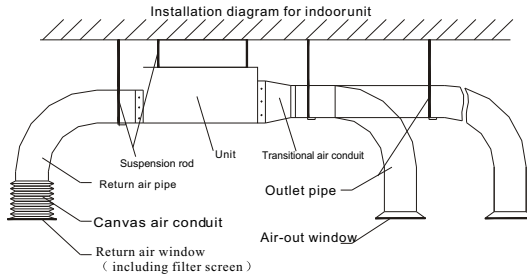

DRAINAGE PIPE INSTALLATION

Low static pressure drainage pipe installation

CAUTION

Be sure to follow this Installation Manual during drainage installation, the drainage pipe must have the heat insulation to prevent condensing.



- The drain pipe of indoor unit must have the heat insulation, or it will condense dew, as well as the connections of the indoor unit.
 - The declivity of the drain pipe downwards should not be over 1/100, and no winding and bending.
 - The total length of the drain pipe when pulled out transversely shall not exceed 20m, when the pipe is over long, a prop stand must be installed every 1.5 to 2m to prevent winding.
 - Refer to the following figures about the installation of the pipes.
- Do not impose any pressure on the connection part of the drainage pipe.

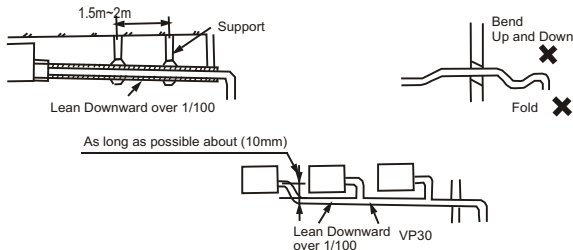

Drainage Pipe Material, Heat-insulating Material

The listed material should be used:

Drainage Pipe
Material

Polyvinyl chloride pipe (32mm outer diameter)

Heat Insulation
Material

Foamed polyethylene insulation plate (10mm thickness)

Connection Procedure

Connect the transparent pipe with the polyvinyl chloride pipe.

Use polyvinyl chloride glue at the connection part of the drainage pipe, be sure no water

- leakage.
- Paste glue at the front 40mm of the polyvinyl chloride pipe, insert it into the transparent pipe.
- It needs 10 minutes for the glue to dry. Do not impose pressure on the connection during the drying period.

Heat Insulation

Wrap the flexible hose carefully with the attached heat insulation material from the start to the end (to indoor part)

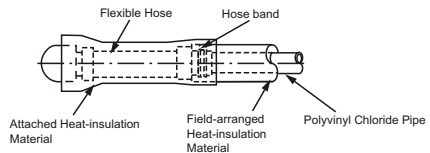

High static pressure drainage pipe installation

Warning:

Must install drainpipes according to the following figure, avoiding generating condensed water and leakage water.

- Assemble the main body according to Figure.
- The opening of drainpipes can be installed on the left side or the right side. Could remove the drain stopper and put it on the left side or the right side.
- For the best effect, should keep pipes as short as possible. Tilt the pipes to ensure the flow of fluid.
- Make sure the drainpipes have admirable heat insulation.
- It is necessary to install a trap near the opening of the drainpipe, so that when the machine is working, the pressure in the inside of the machine is lower than atmospheric pressure. If there isn't an elbow, the water will splash and the pipe will produce a bad smell.
- Keep straightness of drainpipes so as to remove dirt.
- Seal the drainpipe on the other side of the machine, then wrap up the drainpipe in the heat-barrier materials.
- Put water into the drain pan to test whether the water can be discharged swimmingly.
- In humid conditions, please must use an add-on drain pan (commercially available) to cover the whole area of the indoor unit.

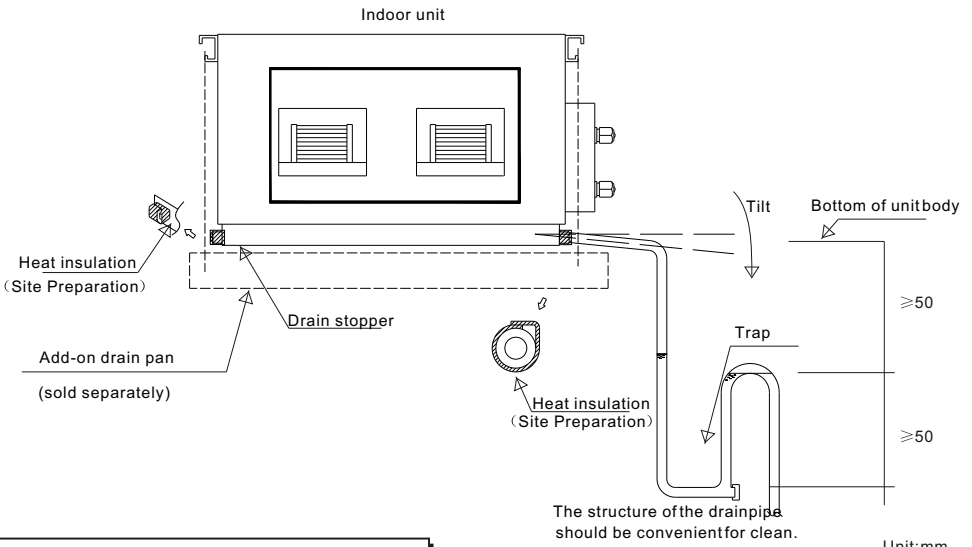
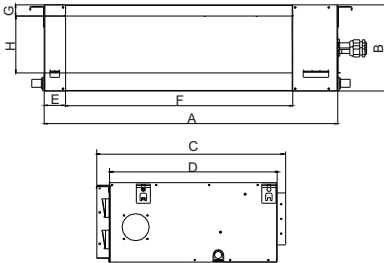
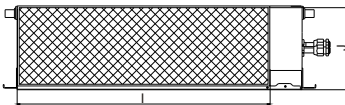

Figure of body size

1. The positioning of ceiling hole, indoor unit and hanging screwbolts.



Air inlet size



Position size of descensional ventilation opening.

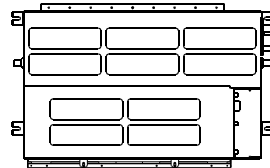

Size of mounted hook

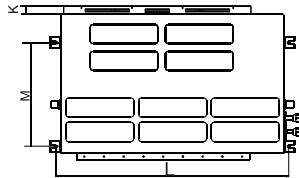

	Outline dimension				Air outlet opening size				Air return opening size			Size of mounted lug	
	A	B	C	D	E	F	G	H	I	J	K	L	M
12/18K	920	210	635	570	65	713	35	119	815	197	36	958	427
24K	920	270	635	570	65	713	35	179	815	260	36	958	427
30/36K	1140	270	775	710	65	933	37	175	1034	260	36	1178	541
42/48/55K	1400	250	720	700	150	1365	15	170	1300	220	20	1440	650

Figure of Body Size

Split type outdoorunit

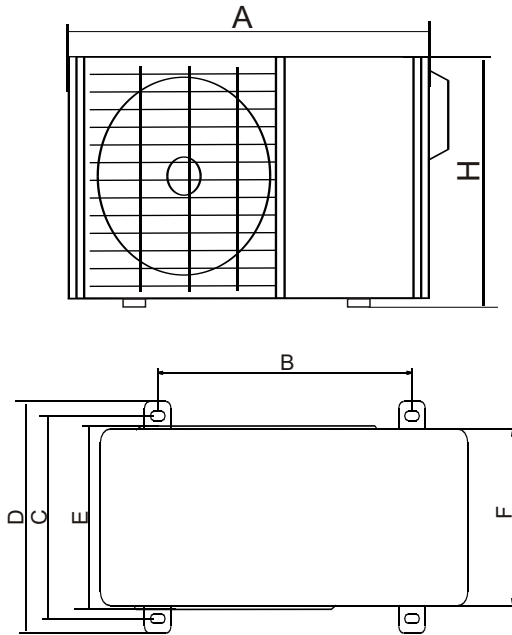

MODE	A	B	C	D	E	F	H
12/18K	780	516	314	350	321	307	605
24/30K	845	574	348	375	358	342	700
36/42K	910	607	390	421	391	378	804
48/55K	1010	660	462	494	440	436	858

CLEANING

 Warning: please shut down the unit and cut off the power before cleaning for safe.

CLEAN THE FILTER

- Clean the unloaded filter with vacuum cleaner or water.
- Scrub with neutral detergent if the filter is too dirty. Do not wash with hot water (about above 50 °C), in case it is out of shape.
- Place it on a ventilated place and cannot be under the sunshine directly after washing lest it is out of shape.
- For your purchasing unit is a rear ventilated one, please remove the filter fixed screws (2screws) and take down the filter a way from the unit.

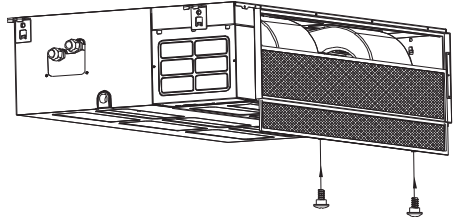

- For your purchasing unit is a descensional ventilate done, please push the filter up slightly to let the position retainer escape away from the flange fixed holes, and take off the filter according to the arrow direction shows in the following fig.

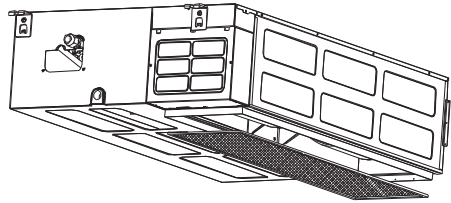

MAINTENANCE

1. Please do the following job well if the air conditioner is not used for a long time.

In order to dry the unit completely, set the FAN mode and runs for 3-4hours.

Shut down the air conditioner and cut off the power supply.

2. When used again after the unit stops for a long period:

When cleaning the filter and indoor unit, you must stop the unit and cut off power supply. Wipe the indoor unit with soft cloth. It is forbidden to push the machine with petrol, benzene, lye, powder, detergent, insecticide etc., Which will damage the unit.

Ensure air in let and outlet of indoor and outdoor unit are not blocked by rubbish.

Check whether the grounded wire is loose and flexible, then connect the power.

AFTER-SALESSERVICE

When your air conditioner can not run in order, please shut down the machine and cut off the power supply immediately. Then contact dealers.

Choose installation location

🏠 INDOOR UNITS

- 1、 A place where there are sufficient space for repair
- 2、 Hung ceiling that can bear the weight of the machine.
- 3、 A place that air inlet and outlet is not hindered and without influence from outdoor air
- 4、 A place without heat source like smoke, fire or toxic pollution.
- 5、 A place where air flow can be transmitted everywhere in the room.
- 6、 A place convenient for installation.

🏠 OUTDOOR UNITS

1. A place where there is sufficient space for installation and repair.
2. A place where the air inlet and outlet are not hindered, without strong air flowing.
3. A dry and ventilated place.
4. A place where the overhanging is level and can bear the weight of the outdoor unit, without much noise.
5. A place where neighbours are not annoyed by noise and exhausted air.
6. A place without leakage of flammable gas.
7. A place convenient for installation.

Caution: (location in the following places may cause malfunction of the machine).

1. A place where there is flammable gas leakage.
2. There is salty air surrounding (near the coast)
3. There is caustic gas (the sulfide, for example) existing in the air.
4. A place where can not bear the weight of the machine
5. In kitchen where it is full of oil gas.
6. There is strong electromagnetic wave existing.
7. There is acid or alkaline liquid evaporating
8. A place where air circulation is not enough.
9. Other special surroundings.

OUTDOOR UNIT INSTALLATION

Move outdoor unit in

1. Please use 4 pieces of 6mm steel wire hanging the outdoor unit up and move in.
2. To avoid the outdoor unit is out of shape, please add the baffles at the surface of outdoor unit where the steel wire rope may touch.
3. After moving, please remove the tray wood on the bottom.

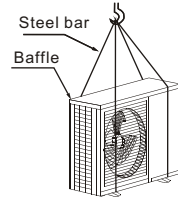

INSTALLATION SPACE

1. After leaving repair space as illustrated below, install the outdoor unit with power supply equipment installed at the side of the outdoor unit. Please refer to ELECTRIC SUPPLY INSTALLATION MANUAL for the installation method.
2. Please make sure necessary space for installation and repair.

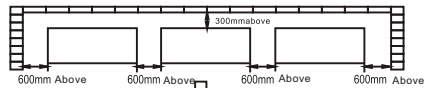
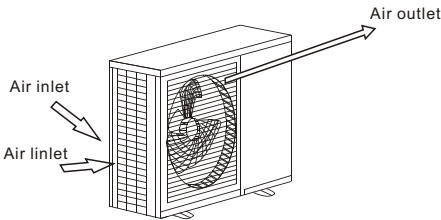

Air outlet of the outdoor unit
Overview of the outdoor unit

⚠ No obstruction from the air outlet of outdoor unit

- At least 600mm space must be left between outdoor units as the sketch indicated.

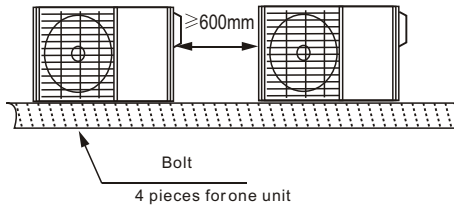

Refrigerant pipe

1. The junction is inside the cover of the right panel, please take off the cover first.
2. The pipe gets out of the side gap of the cover.
3. After connecting from the valve gap, reinstall it from left, right or backwards for installation.
4. The right picture is the sketch map of valve installation board of outdoor. Gas-side (low pressure) is the one upward, liquid side is the one downward.

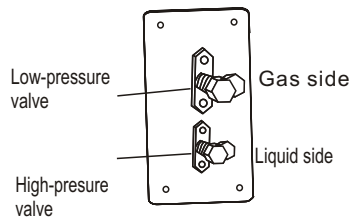

INSTALLATION

Pre-installation precautions

- Please confirm that the installation personnel are qualified in relevant installation service. If the air conditioner was installed by persons without special skills, normal operations would not be ensured, even the personal and estate safety would be affected.

User guideline

- The user's installation site should be provided with regular power supply in conformity with that indicated in nameplate of the air conditioner, and its voltage should be within a range 90 %~ 110 % of the rated voltage value.
- Power circuit should be equipped with protector, such as electricity leakage protector or air switch, which should possess a capacity greater than 1.5 times the maximum current value of the air conditioner.
- Never fail to adopt personal circuit and effectively-grounded socket compatible with the attached plug of the air conditioner. The attached plug is equipped with grounding pin, and it must not be modified as desired.
- Please adopt the fuse or circuit breaker prescribed in Installation Instructions.
- Only qualified electrician is allowed to carry out wiring tasks strictly according to electric safety requirements.
- Do ensure good earth of air conditioner, in other words, the main power switch of air conditioner must be connected to reliable ground wire.

Precautions

- The air conditioner should be installed securely; otherwise poor installation may lead to abnormal noises and vibration.
- Outdoor unit should be installed at a spot ensuring that its air outlet noises and hot exhaust will not violate your neighbors.

Unit body installation

Please confirm the indoor unit dimension according to the picture below
M10 whorl is to be installed.(4 sets)

- ◆ Please refer to the following for the center distance between the bolts
 - ◆ M 10 whorl is used
 - ◆ Please consult professional for your specific ceiling arrangement.
1. Dismantle scale of the ceiling.....please keep ceiling its level. Strengthen the beam to avoid vibration.
 2. Break the beam of the ceiling
 3. Strengthen the breaking point of the ceiling and reinforce the ceiling beam.
- ◆ After the main body hanging is finished, arrangement of pipe and line will be done in the ceiling. The direction of the pipe is determined after the installation location is chosen. If the ceiling has existed, please arrange the refrigerant pipe, drainage pipe, indoor and outdoor connecting line.
 - ◆ Installation of the hanging screw bolt

REFRIGERANT PIPE INSTALLATION

Pipe dimension and ways of installation

Outdoor pipe dimension and ways of install (in sequence of cooling capacity)

Pipe Material		Copper Pipe for Air Conditioner		
Model		12/18K	24K	30/36/42/48/55K
Size(mm)	Liquid side	6.35(7/16inch)	6.35(7/16inch)	9.52(5/8inch)
	Gas side	9.52(5/8inch)	12.7(3/4inch)	15.88(7/8inch)

Conventional pipe, cooling capacity18000-30000Btu/h		Allowed value
Longest pipe(L)		30m
Maximum height drop	Height drop between indoor and outdoor unit	15m

Conventional pipe, cooling capacity36000-42000Btu/h		Allowed value
Longest pipe (L)		50m
Maximum height drop	Height drop between indoor and outdoor unit H	25m

Conventional pipe, cooling capacity48000-55000Btu/h		Allowed value
Longest pipe(L)		60m
Maximum height drop	Height drop between indoor and outdoor unit	30m

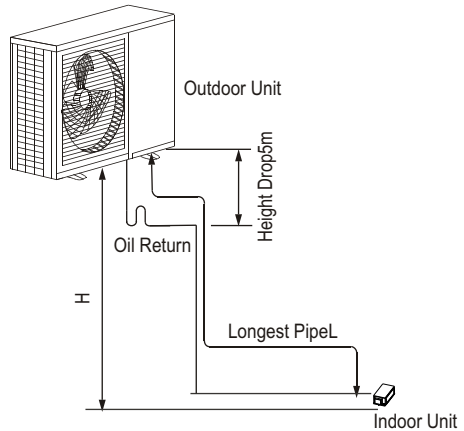

Please refer to refrigerant pipe connection for detail.

Allowed length and height drop

Remove objects and water

- Use high-pressure nitrogen to clean the pipe instead of outdoor refrigerant.
- Before installing refrigerant pipe, please clean the pipe in case of foreign objects.

Additional refrigerant charge

The additional charge is base on the diameter and length of outlet/inlet liquid type . This AC has been charged with that for 5m pipe, those beyond 5 m should recharge as follows.

Liquid pipe diameter	$\phi 1/4''$	$\phi 3/8''$	$\phi 1/2''$
Additional charge for 1m pipe(R32)	0.016kg	0.040kg	0.096Kg

FIARING

- ① Cut the refrigerant pipe off with pipe cutter.

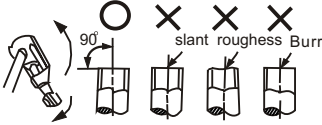

- ② Flaring after putting the pipe into connection nut.

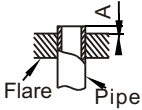

Outside Diameter	A (mm)	
	MAX	MIN
1/4"	8.7	8.3
3/8"	12.4	12.0
1/2"	15.8	15.4
5/8"	19.0	18.6
3/4"	23.3	22.9

Stop valve operation item

- Open the valve rod til to the position rod.
Do not try to open larger.
- Fasten the bonnet with spanner or similar tools.
- Fasten the bonnet of valve rod.
Liquid side(3/8" , 1/2"): 1180Nc m(120kgfcm)
gas side(5/8" , 3/4"): 1180Nc m(120kgfcm)

■ When vacuum pump is used, each low-pressure valve must be manipulated as follow
Please refer to operation manual for the usage of manifold valve.

1. Connect the recharged hose to lower pressure valve junction (low/high pressure valve must be tightened.)
2. Connect the charged hose junction with vacuum pump.
3. Open the low pressure handler of manifold fully.
4. Start vacuumizing with vacuum pump. When vacuumizing begins, loosen the nut of low pressure valve a bit. Check if the air enters (noise of vacuum pump changes, the all-purpose meter indication change from negative to zero), then tighten the nut of connection pipe.
5. After vacuumizing finishing, tighten the low pressure handler of manifold valve fully and stop the vacuum pump. When vacuumizing is carried out for over 15 minutes, please confirm if the all-purpose meter points at -1.0×10^5 Pa (-76cmHg).
6. Open the high/low pressure valve fully.
7. Dismantle the recharged hose from charge gap of low pressure valve.
8. Tighten the bonnet of low-pressure valve.

Junction fixture

- Aim at connection pipe
fix the nut of connection pipe, then tighten]
as the following diagram with spanner

▲ Notice

- According to installation conditions, overlarge wrenched torch will destroy the nut. (Unit. N.cm)

Outside diameter	Stengthen to fasten the torch
1/4"	1420~1720N cm (144~176kgf.cm)
3/8"	3270~3990N cm (333~407kgf.cm)
1/2"	4950~6030N cm (504~616kgf.cm)
5/8"	6180~7540N cm (630~770kgf.cm)
3/4"	9720~11860N cm (990~1210kgf.cm)

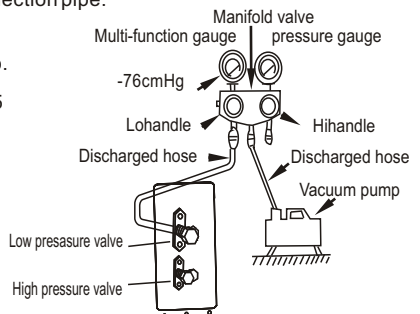
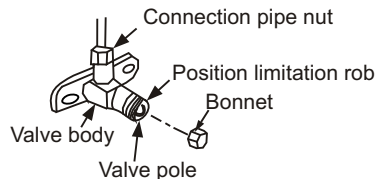
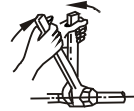

ELECTRIC WIRING

WARNING

Specified power cables should be used. Do not apply any pressure on the terminals used to connect.
Improper connection may cause fire.



Grounding must be properly done.
The grounding wire should be away from gas pipes, water pipes, telephone, lightning rods or other grounding wires. Improper grounding may cause electric shock.



Electric Wiring must be done by professionals. Use a separate circuit according to national regulations.



The temperature of refrigerant circuit will be high, please keep the interconnection away from the copper tube.

If the wiring capacity is not enough, electric shock or fire may occur.
If the supply cord is damaged, it must be replaced by the manufacturer or its service agent or a similarly qualified person in order to avoid a hazard.
An all-pole disconnection switch having a contact separation of at least 3mm in all poles should be connected in fixed wiring.

CAUTION

Be sure to install Current Leakage Protection Switch. Or electric shock may occur.

- Power cord is to be selected according to national regulations.
- Outdoor unit power cord should be selected and connected according to the outdoor unit installation manual.
- Wiring should be away from high temperature components, or the insulation layer of the wires may melt down.
- Use wire clamp to fix the wires and terminal block after connection.
- Control wire should be wrapped together with heat insulated refrigerant pipes.
- Connect the indoor unit to power only after the refrigerant has been vacuumed.
- Don't connect the power wire to the signal wire connection end.



Notice

1. Power cord indicates the supply cable from indoor air switch to indoor unit or outdoor unit.
Indoor/outdoor power connecting wire indicates the supply cable connecting indoor unit and outdoor unit.
2. Cross-section area of power cord wire is the minimum value here. In case power-connecting wire is longer than usual, just select the conductor cross-section a level higher than the specified one to avoid voltage drop.
3. The cross section of ground wire for the whole set of air conditioner should be 2 mm² at least.
Power cord connected to indoor unit should be cable RVV (300 / 500); the power cord connected to outdoor unit and the indoor/outdoor power connecting wire should be multi-wire strand cable (neoprene) YZW (300 / 500V).
4. In case single-core double-layer wire is adopted, its cross section should be one level bigger than the specified one, and the wire should be covered with dedicated electric sheath.

1. Wiring method for indoor unit: Open the electric junction box to carry out wire connection. Notice that the connecting wire should be passed through wire-inlet rubber ring of the box. Connect the wires according to stipulations in the wiring diagram, and the wire splices at connecting terminal should be tightly compacted, free of looseness.

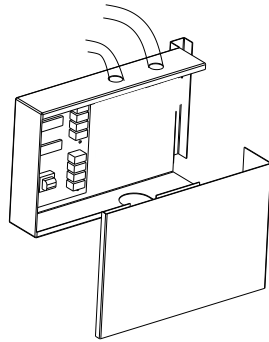

2. Binding treatment

Once the connecting wires have been properly connected, bind the connecting tubing, connecting wire and drain pipe by binding tapes

After binding treatment, the cross section is shown in the figure below:

Notice: Drain pipe must not be flattened during binding treatment.

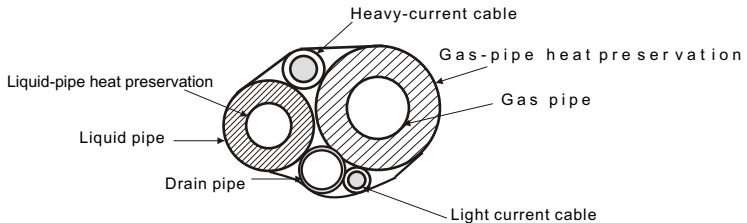

Drain pipe outlet should be led to a place that can avoid affecting the environment.

If situations as follow occur, please cut off the electric power before contacting the dealer

- open or close incorrectly
- fuse or electric leakage protector breaks for several times.
- Objects or water into the AC

3.External wiring diagrams

The following wiring diagram is for use with 12/18/24/30K models.

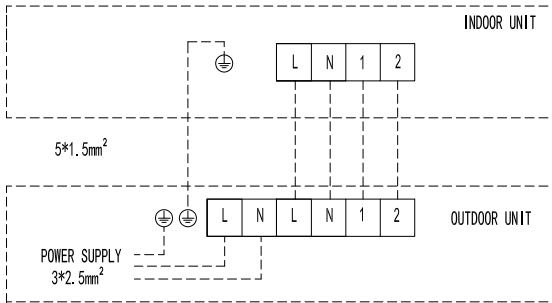

The following wiring diagram is suitable for 36/42K single-phase models.

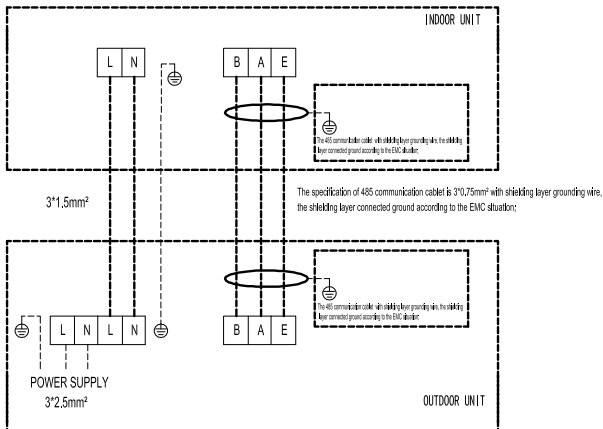

The following wiring diagram is suitable for 48/55K single-phase models.

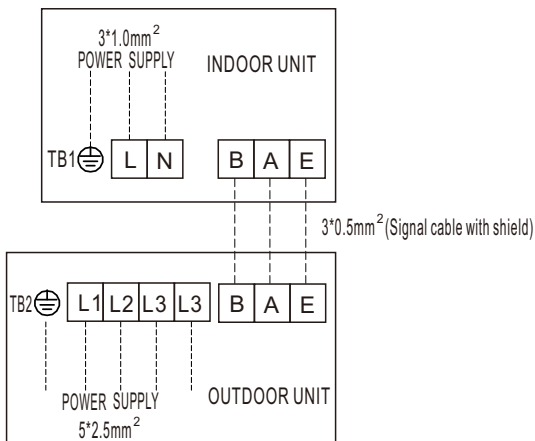

4、 Outdoor unit wiring

1. Copper-cored wire should be selected.
2. As the electric control box is inside the unit body, dismantle the valve installation cover, top cover right front board sequently when connecting wires. Then connect the responding wires from the hole of the electric of the right back board.
3. Mate series number according to junction box of outdoor unit. (Disposed length of connection wire is good enough for inserting the conenction pole completely as the right picture shows.)
4. Wrap the electric wire(conductor),which is not inserted into the connection pole, with PVC belt and make it avoid any electric appliance or metal elements.
5. After installing cable connection lug on the main power wire, then connect to the terminal row.
6. Connection lug should be installed on the grounded wire of all cables.
Only finishing that all cables can be connected to grounded bolt.
7. The electric wire from wire terminal should be through wire clips.
8. Please refer to the right illustration.

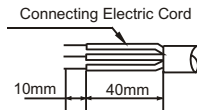

NOTICE

The indoor unit should be connected correctly with the high-pressure and low-presurre stop valve of the outdoor unit as well as the signal line. Otherwise, some electrical componets and system may suffer damages.

TRY TEST

Before testing

- a. Check if piping, drainage and external wiring have been finished correctly.
- b. Check if the power supply complies with requirements; if there is refrigerant leakage; if the all wires and cables are correctly connected and well fixed.

Function test

- a. After checking, energize your appliance and press the buttons on the control panel to see if the buttons function;
- b. If LCD screen displays normally.

Notes

1. Please read this operating and installation instructions carefully.
2. Do not let air in or refrigerant out during installing or reinstalling the appliance.
3. Test run the air conditioner after finishing installation and keep the record .
4. Type of fuse for controller of indoor unit is 50T, rated specification is T 5 A, 250V. Fuse for the whole unit is not supplied by the manufacturer, so the installer must employ a suitable fuse or other over-current protective device for the power supply circuit according to the maximum power input as required.
5. The air conditioner operates safely when ambient static pressure is 0.8~1.05 standard atmosphere pressure.

DISPLAY PANEL

1. Trouble display of indoor display panel

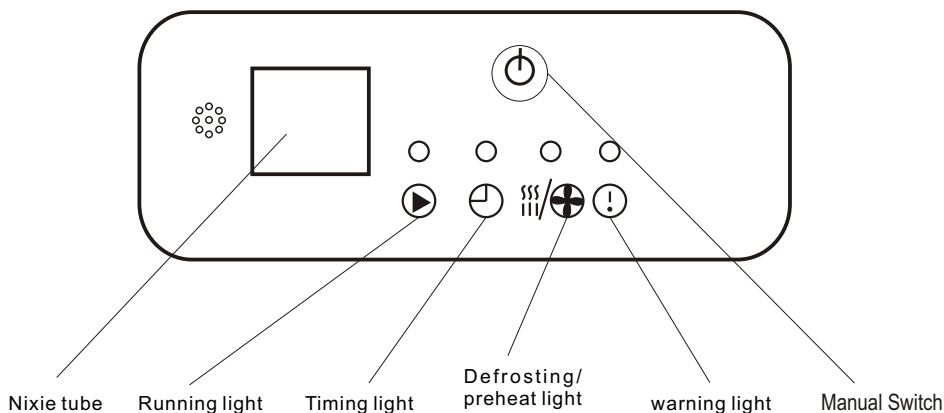

Display function declaration:

LED light the state of running light

When powered-on the first time, the running light twinkles, while the double-8 does not lit.

When started-up normally, the running light lights on, while the double-8 shows the ambient temperature.

When operated normally, the running light lights on, while the double-8 shows the ambient temperature.

When closed down, both LED and double-8 are gone out.

LED light the state of Timing light

When timing set, the timing light lights on, and the double-8 flash shows the time setting within 5 seconds, then shows the ambient temperature.

When without time setting, the timing light gone out, while the double-8 back to the original state.

LED light the state of defrosting/preheat light

When in the state of defrost, oil return, cold-wind proof, the defrosting/preheat light lights on, while the double-8 shows the designed temperature. (One-driven-one does not show the oil return state).

When out of the state of defrost, oil return, cold-wind proof, the defrosting/preheat light gone out, while the double-8 shows the designed temperature. (One-drive-one does not show the oil return state).

LED light the state of warning light

When double-8 shows E* or P*, the running lights gone out, while the warning light lights on.

2. Trouble display of outdoor unit

(1) During standby, the digital tube displays the numbers of indoor unit currently connected and communicating.

(2) When the compressor operates, the digital tube displays the frequency value of the inverter compressor;

(3) The digital tube displays "dxx" during defrosting;
The digital tube displays "Cxx" during oil return

(4) During trouble protection, the information code displayed by the digital tube is as follows:

TROUBLESHOOTING

Error Code	Error Content	Error History Times	Error Definition and Protection
E0	Indoor and outdoor communication failure	1	Hardware Error
E1	Indoor ambient temperature sensor failure	2	Hardware Error
E2	Indoor fan coil temperature sensor failure	3	Hardware Error
E3	Outdoor fan coil temperature sensor failure	4	Hardware Error
E4	Abnormal system malfunction (lack of fluorine)	5	Hardware Error
E5	Model configuration error	6	Hardware Error
E6	Indoor PG/DC fan failure	7	Hardware Error
E7	Outdoor ambient temperature sensor failure	8	Hardware Error
E8	Outdoor exhaust temperature sensor failure	9	Hardware Error
E9	Outdoor IPM module failure/compressor drive failure	10	Hardware Error
EA	Outdoor current sensor failure	11	Hardware Error
Eb	PCB and display screen communication failure	12	Hardware Error
EC	Outdoor modules communication failure	13	Hardware Error
EE	Outdoor EEPROM fault	14	Hardware Error
EF	Outdoor DC fan failure	15	Hardware Error
EH	Outdoor suction sensor failure	16	Hardware Error
EP	Outdoor compressor casing top failure	17	Hardware Error
EU	Outdoor voltage sensor failure	18	Hardware Error
Ej	Outdoor central coil temperature sensor failure	30	Hardware Error
En	Outdoor air pipe temperature sensor failure	31	Hardware Error
Ey	Outdoor liquid pipe temperature sensor failure	32	Hardware Error
P0	IPM module protection	19	Others Error
P1	Overvoltage and undervoltage protection	20	Others Error
P2	Overcurrent protection	21	Others Error
P3	Other protections	22	Others Error
P4	Protection against excessive outdoor exhaust temperature	23	Others Error
P5	Cooling protection against overcooling	24	Others Error
P6	Cooling and anti-overheating protection	25	Others Error
P7	Heating and anti-overheating protection	26	Others Error
P8	Protection against high or low outdoor temperature	27	Remote control display adjustment
P9	Compressor drive protection (abnormal load)	28	Others Error
PA	Communication failure/mode conflict	29	Others Error
F0	Infrared human sensing sensor failure	33	Remote control display adjustment

Error Code	Error Content	Error History Times	Error Definition and Protection
F1	Battery module failure	34	Remote control display adjustment
F2	Exhaust temperature sensor failure protection	35	Others Error
F3	Failure protection of outer tube temperature sensor	36	Others Error
F4	Abnormal protection of refrigerant circulation	37	Others Error
F5	PFC protection	38	Others Error
F6	Compressor missing/reverse phase protection	39	Others Error
F7	Module temperature protection	40	Others Error
F8	Abnormal commutation of four-way valve	41	Others Error
F9	Module temperature sensor circuit malfunction	42	Hardware Error
FA	Compressor phase current detection fault	43	Hardware Error
Fb	Cooling and heating overload protection limit frequency reduction	44	Remote control display adjustment
FC	High power protection limit/frequency reduction	45	Remote control display adjustment
FE	Module current (compressor phase current) protection limit/frequency reduction	46	Remote control display adjustment
FF	Module temperature protection limit/ frequency reduction	47	Remote control display adjustment
FH	Drive protection limit/frequency reduction	48	Remote control display adjustment
FP	Anti condensation protection limit/frequency reduction	49	Remote control display adjustment
FU	Anti freezing protection limit/frequency reduction	50	Remote control display adjustment
Fj	Exhaust protection limit/frequency reduction	51	Remote control display adjustment
Fn	External AC current protection limit/ frequency reduction	52	Remote control display adjustment
Fy	Fluorine deficiency protection	53	Others Error
H1	High pressure switch malfunction	54	Hardware Error
H2	Low pressure switch malfunction	55	Hardware Error
bf	TVOC sensor failure	56	Remote control display adjustment
bc	PM2.5 sensor failure	57	Remote control display adjustment
bj	Humidity sensor failure	58	Remote control display adjustment
bE	CO2 sensor malfunction	59	Hardware Error
bd	Fresh air fan failure	60	Hardware Error
d4	Water full protection	61	Others Error
d5	Access control protection	62	Hardware Error

REFRIGERANT NOTICE/CONCENTRATION

This air conditioner uses R32 refrigerant. The construction area for installation, operation and storage of the air conditioner must be larger than the minimum construction area. The minimum area for installation is determined by:

1.Refrigerant charging quantity for the entire system (ex-factory charging quantity + additional charging quantity);

2.Checking out in the applicable tables:

(1) For indoor unit, confirm the model of indoor unit and check the corresponding table.

(2) For outdoor unit that is installed or placed indoors, select the corresponding table according to the height of the room.

Height of the room	Select the applicable table
< 0m	Floor standing type
1.8m	Wall mounted type
2.2m	Ceiling type

3.Refer to the following table to check out the minimum construction area.

Ceiling type		Wall mounted type		Floor standing type	
Weight (kg)	Area (m ²)	Weight (kg)	Area (m ²)	Weight (kg)	Area (m ²)
<1.224	—	<1.224	—	<1.224	—
1.224	0.956	1.224	1.43	1.224	12.9
1.4	1.25	1.4	1.87	1.4	16.8
1.6	1.63	1.6	2.44	1.6	22.0
1.8	2.07	1.8	3.09	1.8	27.8
2.0	2.55	2.0	3.81	2.0	34.3
2.2	3.09	2.2	4.61	2.2	41.5
2.4	3.68	2.4	5.49	2.4	49.4
2.6	4.31	2.6	6.44	2.6	58.0
2.8	5.00	2.8	7.47	2.8	67.3
3.0	5.74	3.0	8.58	3.0	77.2
3.2	6.54	3.2	9.76	3.2	87.9
3.4	7.38	3.4	11.0	3.4	99.2
3.6	8.27	3.6	12.4	3.6	111
3.8	9.22	3.8	13.8	3.8	124
4.0	10.2	4.0	15.3	4.0	137
4.2	11.3	4.2	16.8	4.2	151
4.4	12.4	4.4	18.5	4.4	166
4.6	13.5	4.6	20.2	4.6	182
4.8	14.7	4.8	22.0	4.8	198
5.0	16.0	5.0	23.8	5.0	215
5.2	17.3	5.2	25.8	5.2	232
5.4	18.6	5.4	27.8	5.4	250
5.6	20.0	5.6	29.9	5.6	269
5.8	21.5	5.8	32.1	5.8	289
6.0	23.0	6.0	34.3	6.0	309
6.2	24.5	6.2	36.6	6.2	330
6.4	26.1	6.4	39.1	6.4	351
6.6	27.8	6.6	41.5	6.6	374
6.8	29.5	6.8	44.1	6.8	397
7.0	31.3	7.0	46.7	7.0	420
7.2	33.1	7.2	49.4	7.2	445
7.4	34.9	7.4	52.2	7.4	470
7.6	36.9	7.6	55.1	7.6	496
7.8	38.8	7.8	58.0	7.8	522
8.0	40.8	8.0	61.0	8.0	549



**IMPORTANT INFORMATION FOR CORRECT DISPOSAL OF THE PRODUCT
IN ACCORDANCE WITH EC DIRECTIVE 2002/96/EC.**

At the end of its working life, the product must not be disposed of as urban waste. It must be taken to a special local authority differentiated waste collection centre or to a dealer providing this service.

Disposing of a household appliance separately avoids possible negative consequences for the environment and health deriving from inappropriate disposal and enables the constituent materials to be recovered to obtain significant savings in energy and resources. As a reminder of the need to dispose of household appliances separately, the product is marked with a crossed-out wheeled dustbin.

ASTON COM S.A., Str. Linia de Centura, nr. 46, VGP Park Bucharest,
Cladirea C, Sat Stefanestii de Jos, Comuna Stefanestii de Jos, judet Ilfov, 077175, Romania